

For enquiries contact
ICR Property & Investment Group
Head Office (03) 9415 1332
David Gibbs 0418 820 181

Email: glassworks@icrproperty.com.au
Visit: <http://glassworks.icrproperty.com.au>
(Alternatively contact your preferred agent).

SHOWROOM 7 FLOOR PLAN:

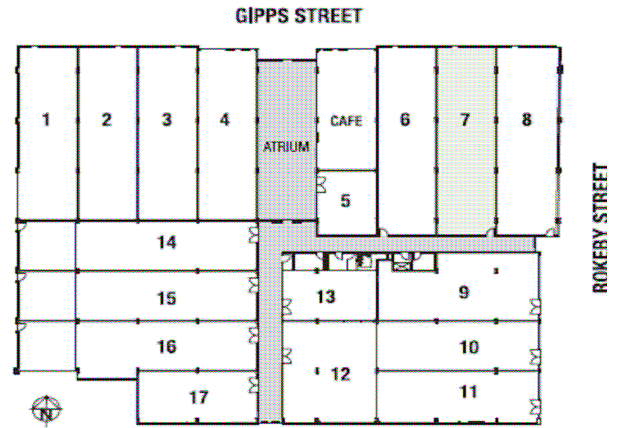
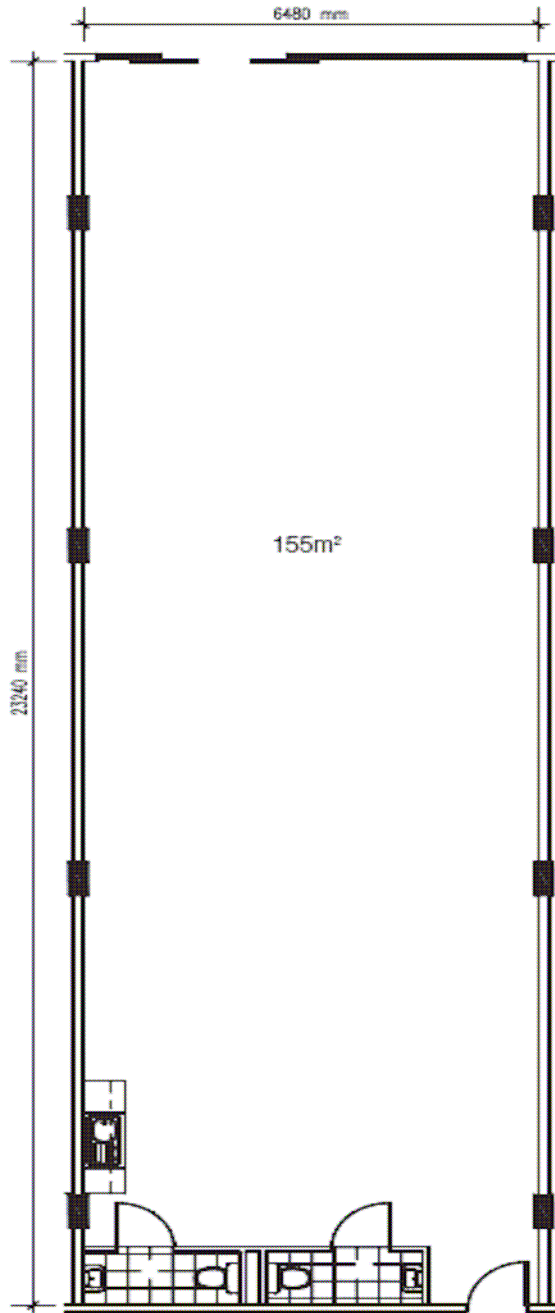

LOCATION PLAN

Features:

- Fronts Gipps Street
- Automatic entry doors
- Reverse cycle air conditioning
- Male and female toilets
- Kitchen facilities
- 2 car spaces
- Visitor parking

* Optional partitions & fit out available